



# Little Free Library



Plans so simple even I could follow them

# Overview



These plans will result in a two-shelf library with optional side shelf for decoration.  
Drawings are not to scale; dimensions are approximate. Consider width of saw blade in cuts and level of precision desired.  
Customize library easily by modifying these concept illustrations.

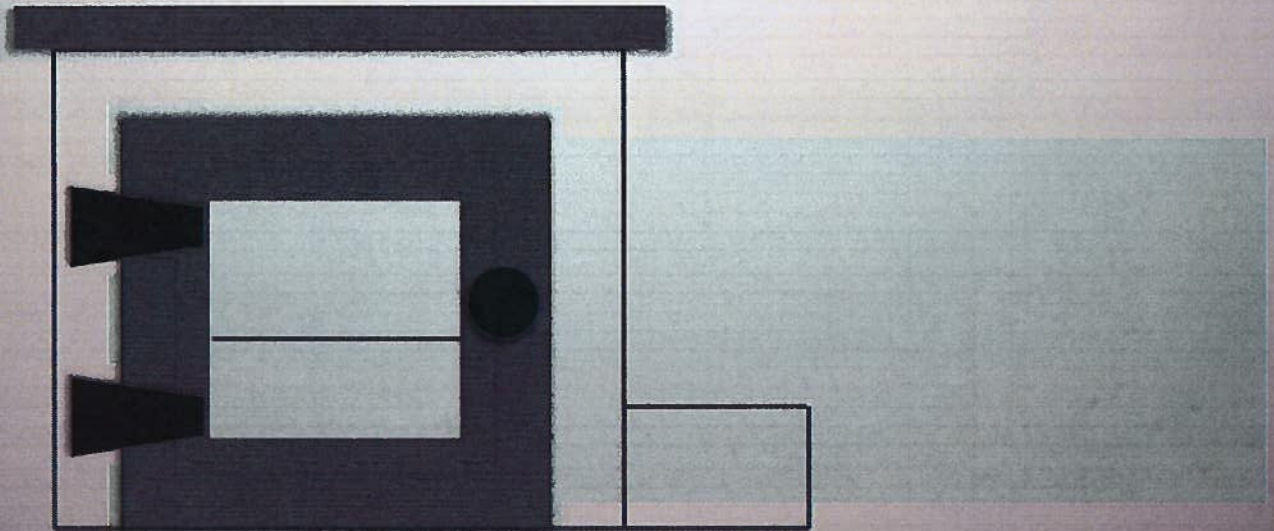



# Ingredients

- ✦ Two sheets of  $\frac{3}{4}$ " thick nominal 4' x 8' CDX (exterior grade) plywood.
- ✦ Four three-inch flat L-brackets.
- ✦ A sheet of  $\frac{1}{16}$ " thick plexiglass, at least 15" x 15".
- ✦ 12  $\frac{1}{16}$ " or  $\frac{1}{8}$ " window screen clips.
- ✦ Two flush type hinges (hinges that lie flat).
- ✦ A door handle.
- ✦ A box of 2.5" exterior grade screws.



# Step 1: Cut Sides

- ✦ There are two side panels.
- ✦ Cut each side 15 inches wide by 24 inches high.
- ✦ The height varies because the roof should be sloped to keep out precipitation. Cut one end on each piece at a  $6^\circ$  slope. This will result in each side piece being 24 inches high on one side, and 22 on the opposite side.
- ✦ Cut a notch out of the corner of one piece,  $4.5'' \times \frac{3}{4}''$ . Be sure to cut out of the shorter end of the piece (the 22'' end).

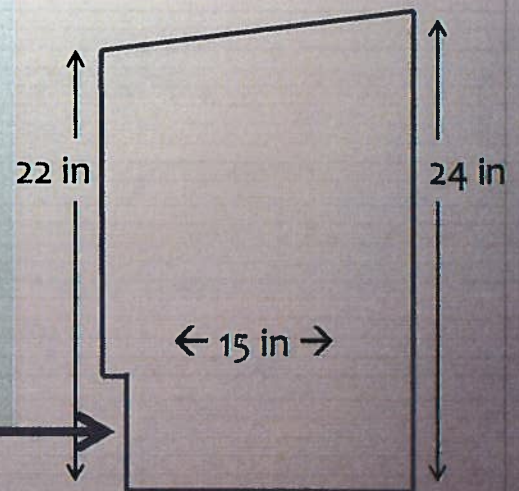



# Step 2: Cut Back

- ✦ Cut the piece 22" x 37".
- ✦ Cut each side 15 inches wide by 24 inches high.
- ✦ 9.5" inches in from the right, cut down 17.5 inches.
- ✦ Shave off from the top a 6 degree angle.

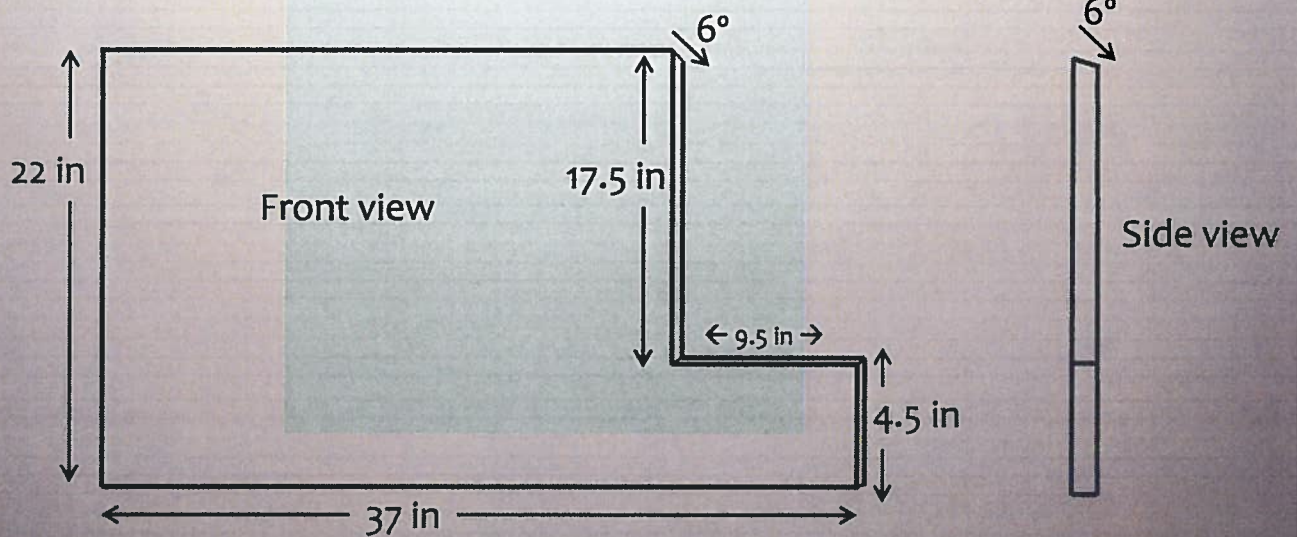

# Step 3: Cut Bottom



✦ Cut the piece 15" x 37".

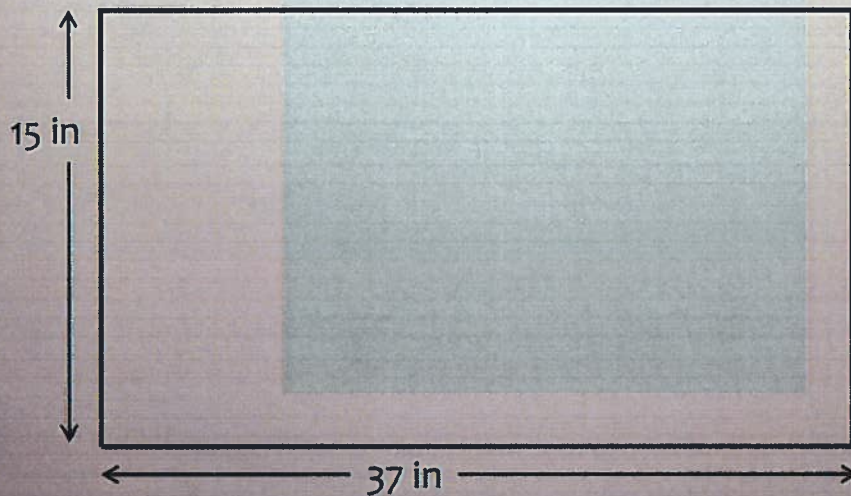

# Step 4: Cut Roof



- ✦ Cut the piece 21.5" x 32".
- ✦ Cut the long sides at a 6 degree angle.
- ✦ If you're running out of plywood, it's okay to cut the piece shorter than 21.5". Don't go less than 18", though.

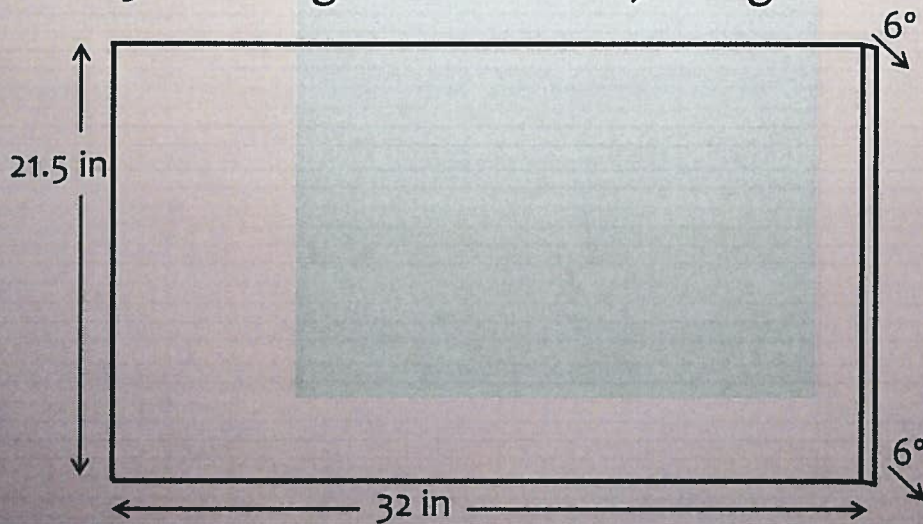





# Step 5: Frame Assembly

- ✦ Assemble the five pieces using 3" outdoor screws. Use four screws for every two pieces.
- ✦ Pre-drill all holes to avoid splitting wood. Pre-drilling also controls direction of screws, making fabrication easier. Counter sink pre-drilled holes to improve aesthetics
- ✦ If you have difficulty keeping the pieces in place while drilling, hammer in small nails first to hold the pieces in place.

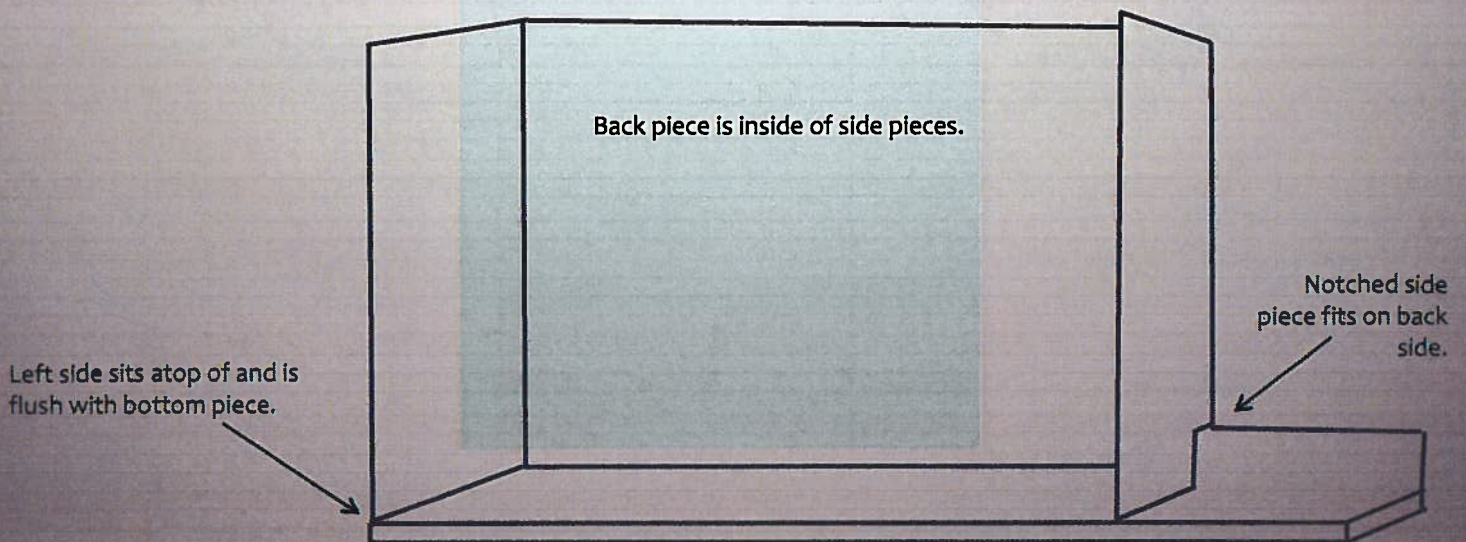





# Step 6: Roof Installation

- ✦ Install roof so that it overhangs the left and right sides equally (approximately 2 inches on each side).
- ✦ Ensure that roof overhangs front of library by 3.5 – 4 inches.
- ✦ Install using 2.5" outdoor screws. Use four screws for each side.
- ✦ Predrill all holes to avoid splitting wood.

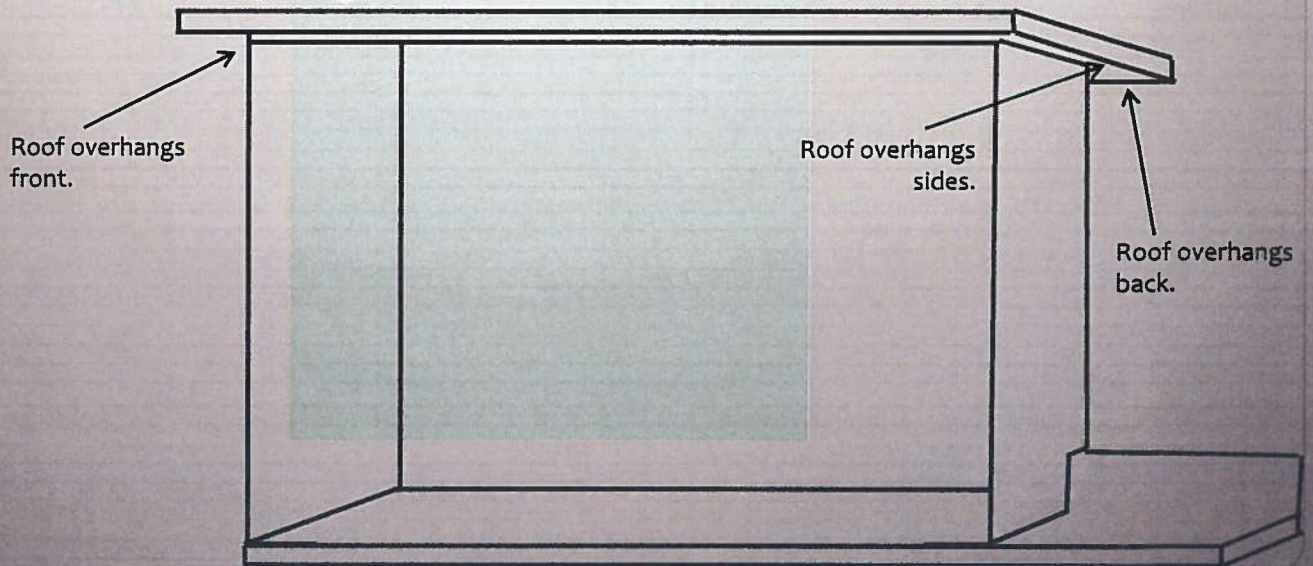

# Step 7: Interior Decorating

- ✦ Cut two shelves 14" deep by approximately 36" long. Measure the inside of your library first, though, to be sure the center shelf will fit. Ensure your shelf will be long enough to bridge from the left side to the right, but short enough so that you can slide it in easily.
- ✦ Using scrap wood, cut two pieces as brackets, about 1" x 1" x 12". Affix one of them to one interior side of the library approximately 8" from the bottom.
- ✦ Set the shelf on the bracket you have screwed in. Set a level on the shelf and determine where the other bracket should be affixed.
- ✦ If you plan to paint, stain, or in some way decorate the interior, this is the time to do that.
- ✦ Set the other shelf on the bottom floor of the library.

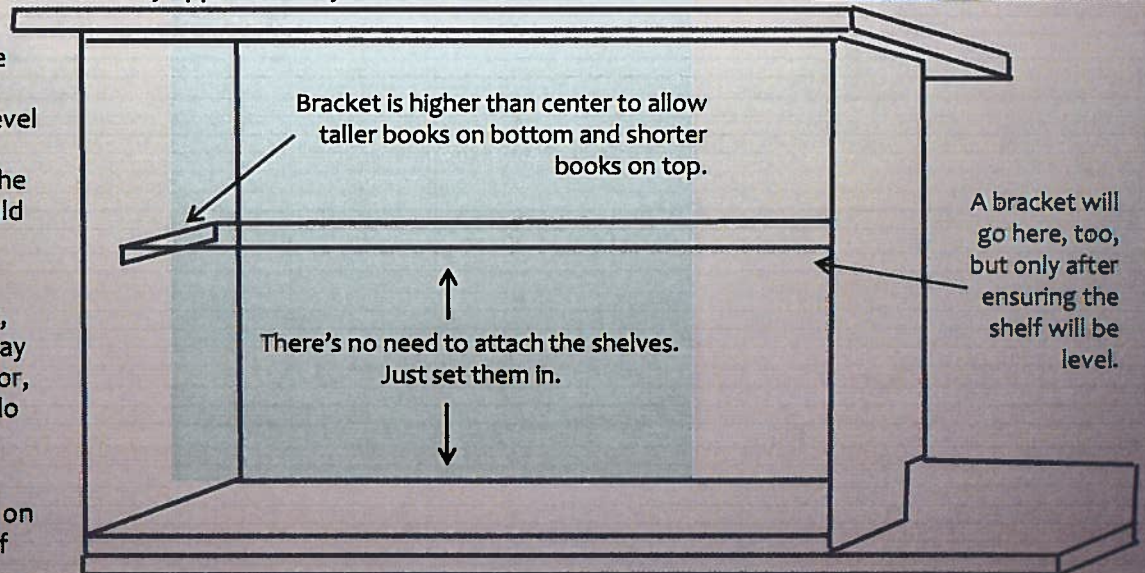



# Step 8: Cut Front Pieces

- ✦ There are three pieces for the front.
- ✦ Cut two pieces 22" x 3".
- ✦ Cut one piece 26.25" x 2 inches. Make a 6 degree cut on one long edge of this piece.
- ✦ It's a good idea to cut these pieces a bit long to compensate for wood thickness and accuracy of other cuts. You can always trim a bit off later, if need be.

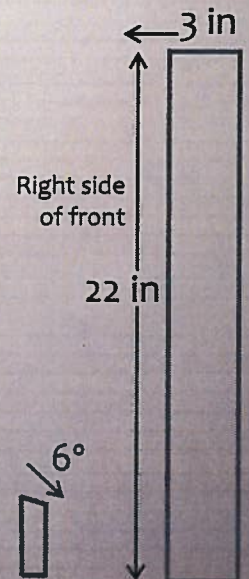
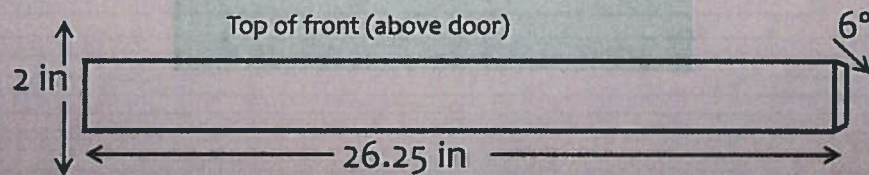
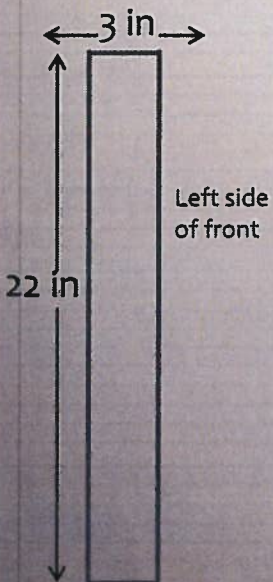



# Step 9: Front Assembly

- + Affix the three front pieces using 3" outdoor screws. Trim pieces if they're too long. Use four screws for each piece.
- + Predrill all holes to avoid splitting wood.
- + If you have difficulty keeping the pieces in place while drilling, hammer in small nails first to hold the pieces in place.

+ Screw in from the outside, as shown here. That way, the screw heads will be covered by trim. Clamp the pieces in place while drilling.

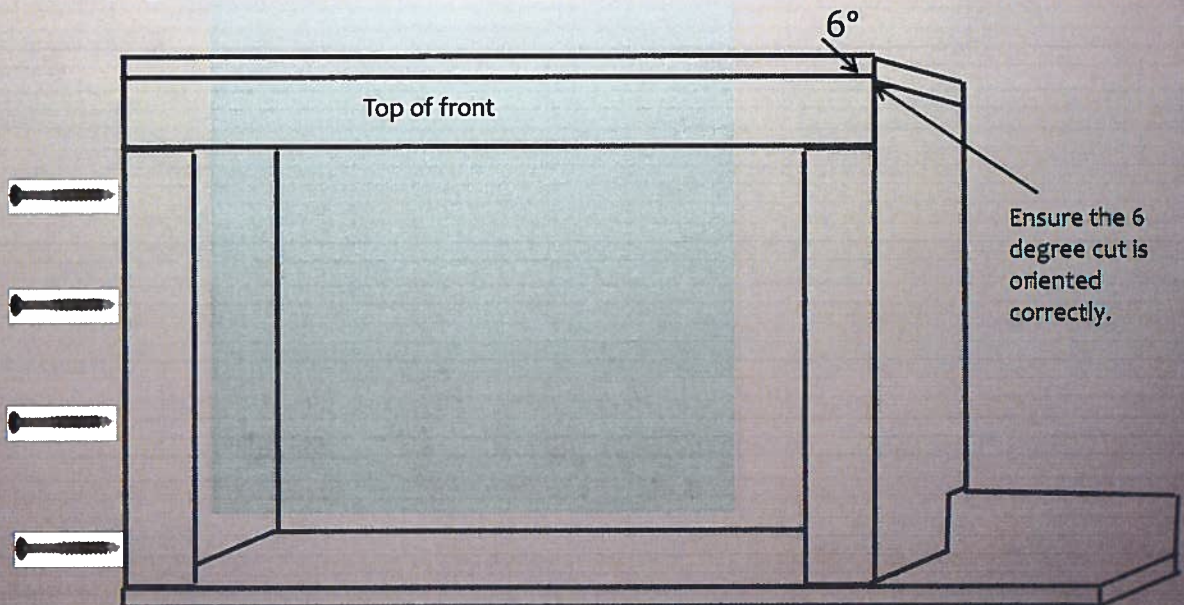



# Step 10: Create Door

- ✦ Cut four pieces 4" x 20.5".
- ✦ Cut 45 degree angles into each side of each piece, as shown below.
- ✦ Glue pieces.
- ✦ Paint or stain, if desired.
- ✦ Attach L-brackets using 1/2" screws.

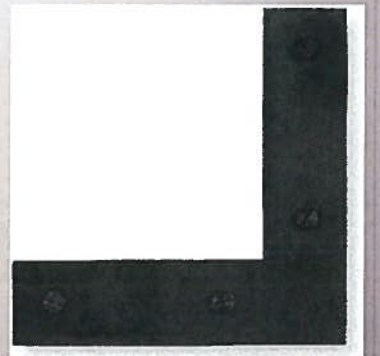
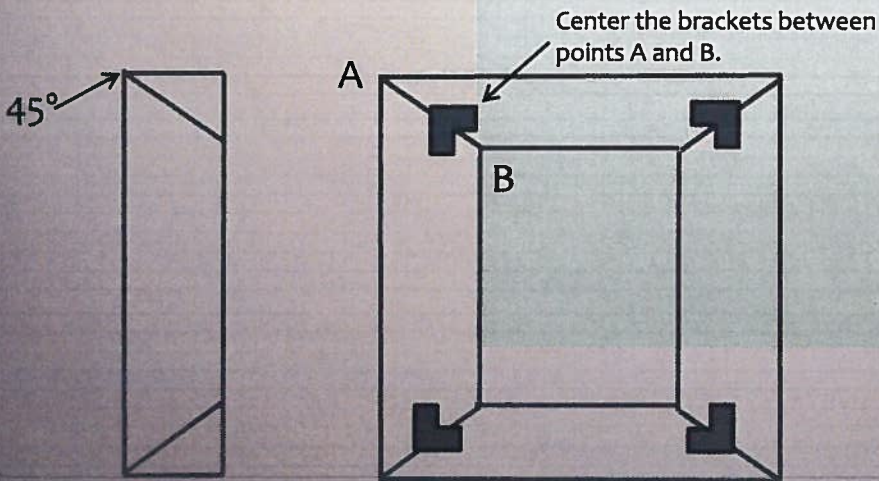

# Step 10: Create Door

- ✦ On the same side of the door as the L-brackets, attach three window screen clips on each side of the center opening, approximately one inch from the opening. Do not screw them on tightly.
- ✦ Cut the plexiglass so that it fits under the window screen clip's tabs, approximately 15" x 15".
- ✦ Swivel the clips so the plexiglass fits in place, then swivel them to hold the plexiglass secure. Tighten the screws a bit, if necessary, to hold them in place.

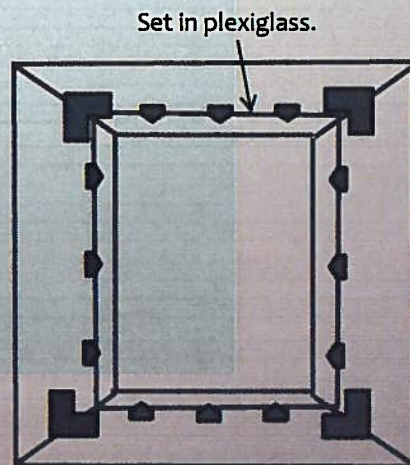
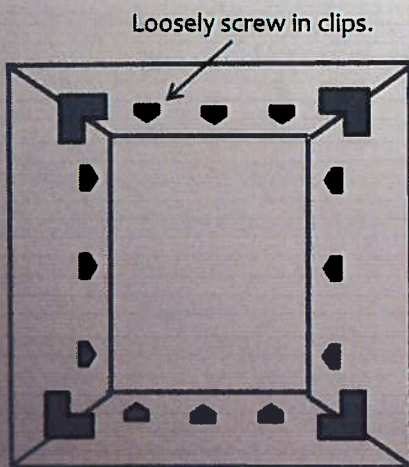



# Step 11: Exterior Decorating



- ✦ Prior to attaching door, paint or stain as desired.
- ✦ Ensure door fits securely, but not too tight. Sand if necessary.
- ✦ Attach fascia trim, if desired. Trim will help prevent moisture from entering. Caulk edges where plywood and trim meet to further reduce moisture.
- ✦ Seal the roof, or install shakes or shingles.
- ✦ Apply exterior-grade primer or paint.

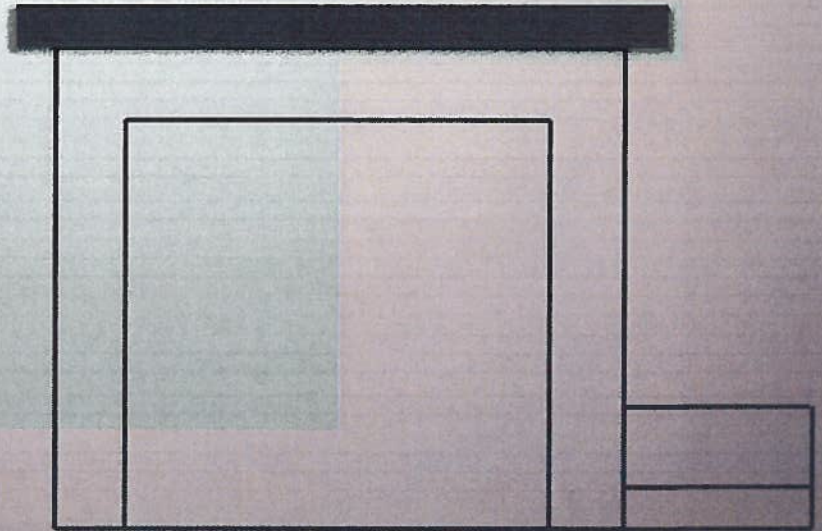

# Step 11: Exterior Decorating

- ✦ If installing shakes, lay a sheet of tar paper under each row, but be sure to cut it off 3 inches from the back of the library so that it does not show through.
- ✦ Nail in a row of shakes so that the row overhangs the back of the library by 3 inches.
- ✦ Lay another row of tar paper. Ensure it ends six inches higher than the last row.
- ✦ Nail in another row of shakes such that the end three inches higher than the previous row.
- ✦ Repeat until roofing is complete. For the last two or three rows, you will need to cut the thin edges of the shakes; shortening them so they fit.





# Step 12: Install Door

- ✦ Affix hinges to left side of door, with one hinge in the top third of the door and another on the bottom third. Ensure the hinges overhang sufficiently to allow for proper motion.
- ✦ Pre-drill all holes.
- ✦ Set door into library's opening and affix left side of screws.
- ✦ Attach L-brackets using  $\frac{1}{2}$ " screws.

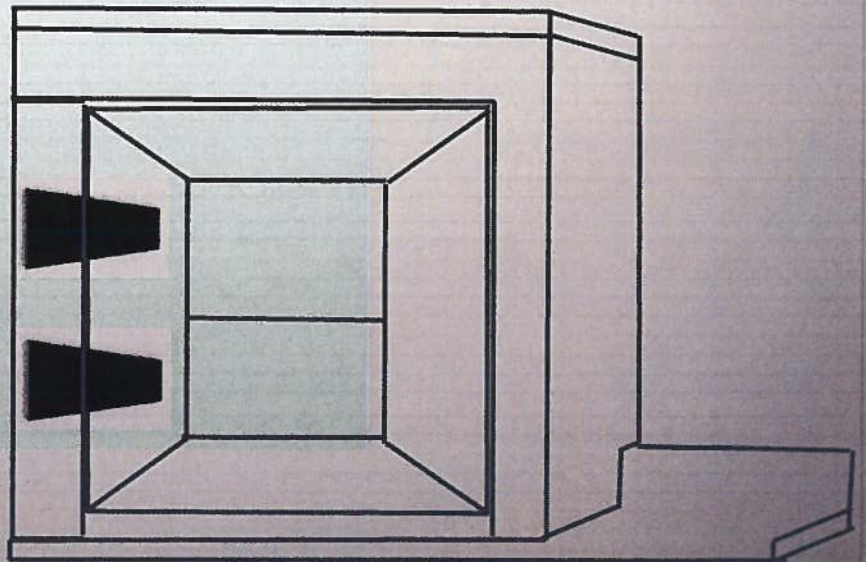

# Step 13: Install Latch

- ✦ The simplest latch is a hook-and-eye. Screw bot pieces into a predrilled hole.
- ✦ Another option is a catch with handle, but then you will need to install a piece on the inside that will hold the catch.

